

SMALL SIGNAL SCHOTTKY DIODES

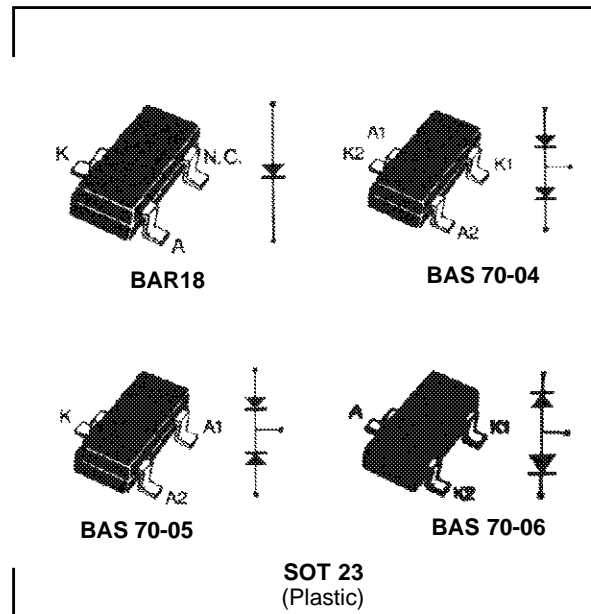

DESCRIPTION

Low turn-on and high breakdown voltage diodes intended for ultrafast switching and UHF detectors in hybrid micro circuits.

ABSOLUTE RATINGS (limiting values)

Symbol	Parameter	Value	Unit
V_{RRM}	Repetitive Peak Reverse Voltage	70	V
P_{tot}	Power Dissipation* $T_{amb} = 25\text{ }^{\circ}\text{C}$	100	mW
T_{stg} T_j	Storage and Junction Temperature Range	- 55 to +150 - 55 to +150	$^{\circ}\text{C}$ $^{\circ}\text{C}$

THERMAL RESISTANCE

Symbol	Test Conditions	Value	Unit
$R_{th(j-a)}$	Junction-ambient*	625	$^{\circ}\text{C/W}$
$R_{th(j-SR)}$	Junction-substrate	400	$^{\circ}\text{C/W}$

* Mounted on ceramic substrate: 7 x 5 x 0.5mm.

ELECTRICAL CHARACTERISTICS

STATIC CHARACTERISTICS

Symbol	Test Conditions		Min.	Typ.	Max.	Unit
V_{BR}	$T_{amb} = 25^{\circ}C$	$I_R = 10\mu A$	70			V
V_F	$T_{amb} = 25^{\circ}C$	$I_F = 1mA$			410	mV
I_R	$T_{amb} = 25^{\circ}C$	$V_R = 50V$			200	nA

DYNAMIC CHARACTERISTICS

Symbol	Test Conditions			Min.	Typ.	Max.	Unit
C	$T_{amb} = 25^{\circ}C$	$V_R = 1V$	$f = 1MHz$			2	pF
τ^*	$T_{amb} = 25^{\circ}C$	$I_F = 5mA$	Krakauer Method			100	ps

* Effective carrier life time.

Figure 1. Forward current versus forward voltage at low level (typical values).

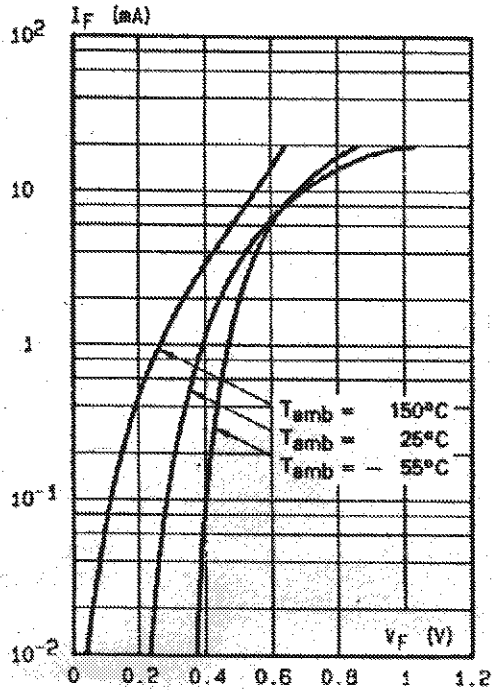

Figure 2. Capacitance C versus reverse voltage V_R (typical values).

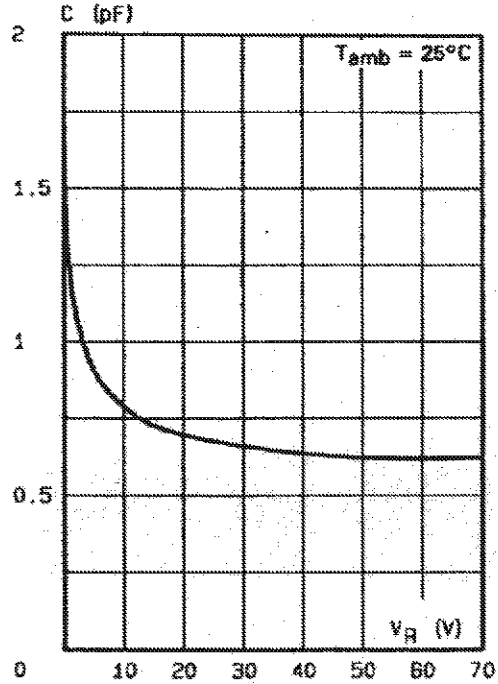

Figure 3. Reverse current versus ambient temperature.

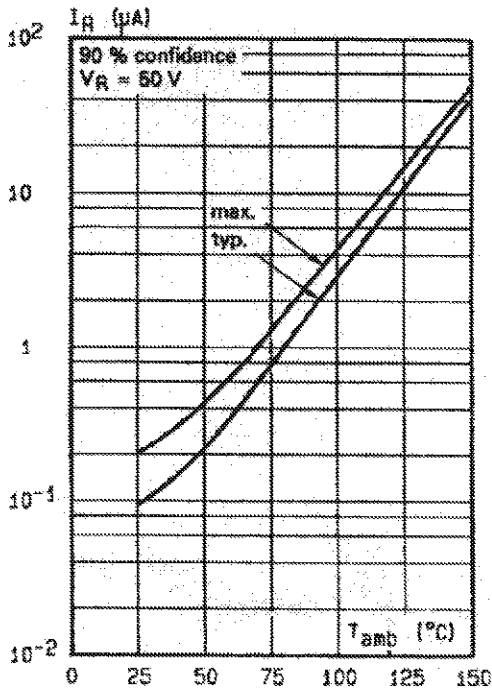
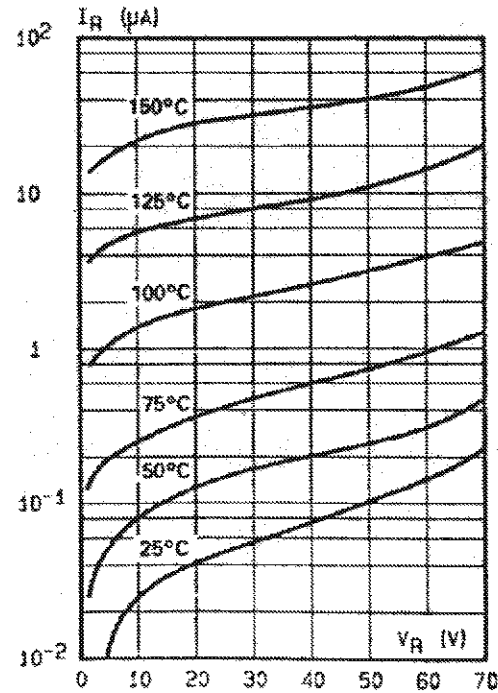

Figure 4. Reverse current versus continuous reverse voltage (typical values).



PACKAGE MECHANICAL DATA

FOOT PRINT DIMENSIONS (Millimeter)

SOT 23 (Plastic)

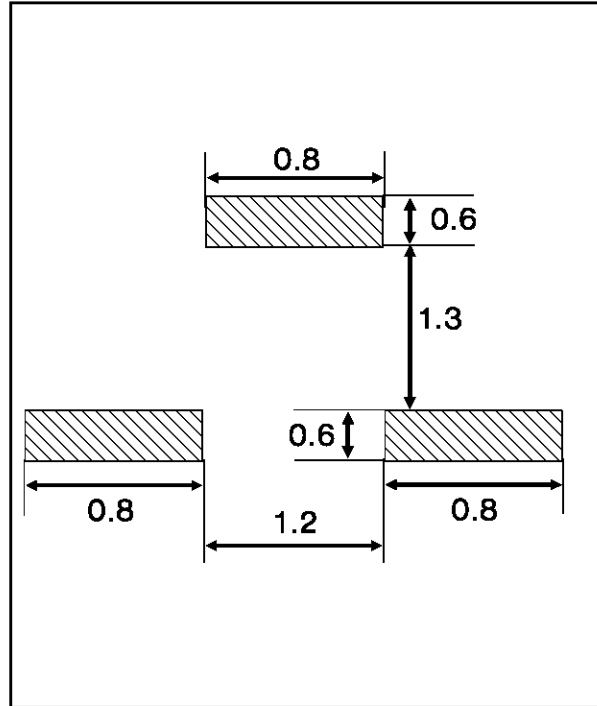
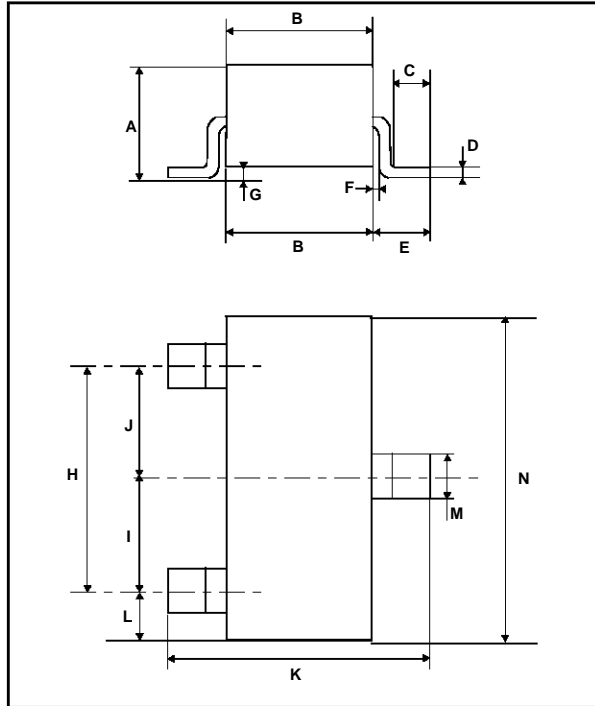

REF.	DIMENSIONS			
	Millimeters		Inches	
	Min.	Max.	Min.	Max.
A	0.93	1.04	0.036	0.041
B	1.20	1.40	0.047	0.055
C	0.15		0.006	
D	0.085	0.115	0.003	0.005
E	0.45	0.60	0.018	0.024
F	0.08		0.003	
G	0.013	0.10	0.0005	0.004
H	1.90	2.05	0.075	0.081
I	0.95	1.05	0.037	0.041
J	0.95	1.05	0.037	0.041
K	2.10	2.50	0.083	0.098
L	0.45	0.60	0.018	0.024
M	0.37	0.46	0.015	0.018
N	2.80	3.00	0.110	0.118

Type	BAR 18	BAS 70-04	BAS 70-05	BAS 70-06
Marking	D76	D96	D97	D98

Information furnished is believed to be accurate and reliable. However, SGS-THOMSON Microelectronics assumes no responsibility for the consequences of use of such information nor for any infringement of patents or other rights of third parties which may result from its use. No license is granted by implication or otherwise under any patent or patent rights of SGS-THOMSON Microelectronics. Specifications mentioned in this publication are subject to change without notice. This publication supersedes and replaces all information previously supplied. SGS-THOMSON Microelectronics products are not authorized for use as critical components in life support devices or systems without express written approval of SGS-THOMSON Microelectronics.

© 1994 SGS-THOMSON Microelectronics - Printed in Italy - All rights reserved.

SGS-THOMSON Microelectronics GROUP OF COMPANIES

Australia - Brazil - France - Germany - Hong Kong - Italy - Japan - Korea - Malaysia - Malta - Morocco - The Netherlands - Singapore - Spain - Sweden - Switzerland - Taiwan - United Kingdom - U.S.A.